

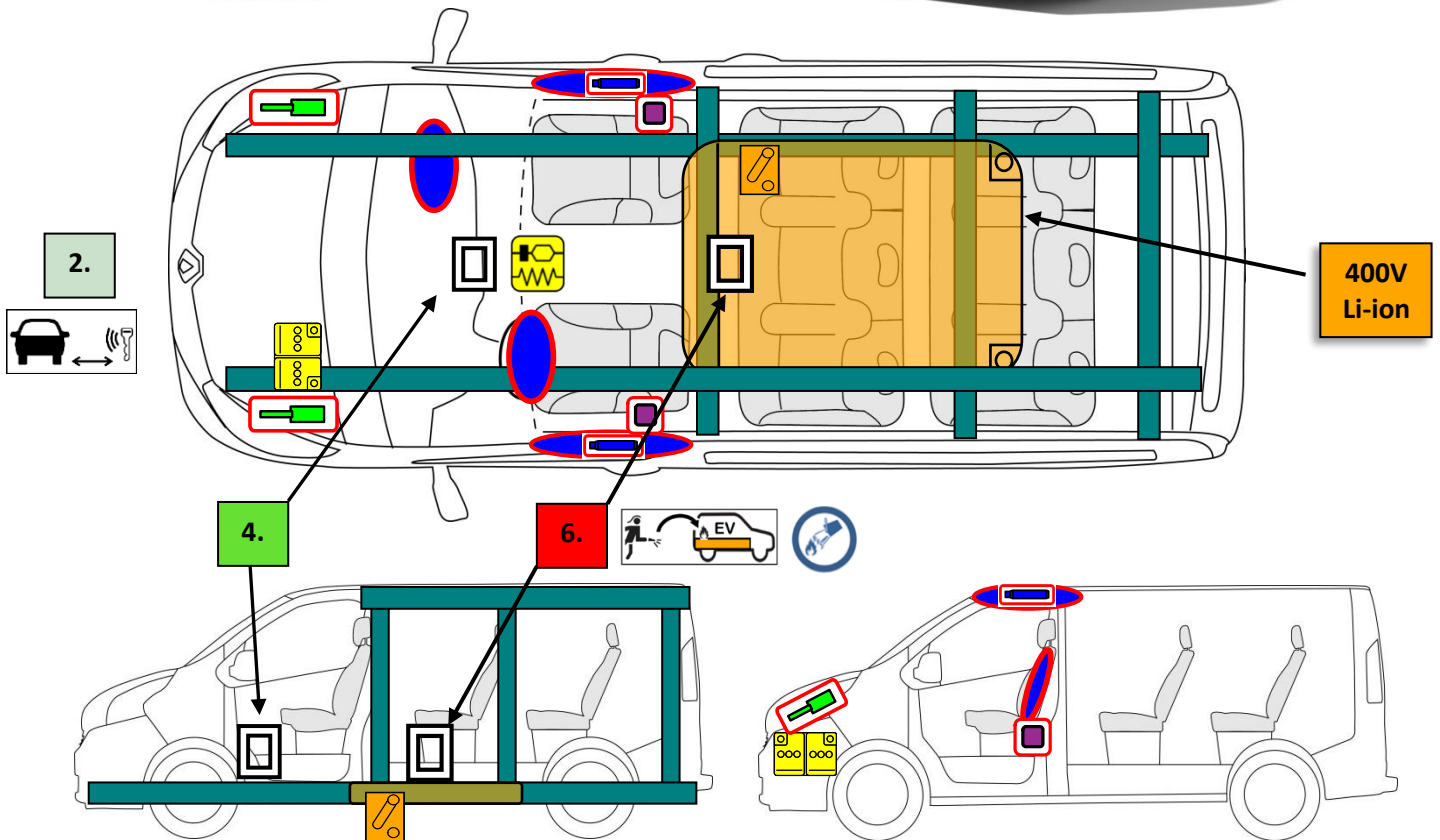

RENAULT

TRAFIC VAN E-TECH Electric

Tous types
(2023 -)



	Airbag		Générateur de gaz		Prétensionneur de ceinture de sécurité		Unité de contrôle SRS		
			Vérin à gaz / ressort précontraint		Zone de haute résistance		Zone nécessitant une attention particulière		
	Batterie basse tension								
	Bloc-batterie, haute tension		Câble d'alimentation haute tension		Dispositif de déconnexion haute tension de la batterie haute tension				

En concertation avec



MINISTÈRE DE L'INTÉRIEUR

Référence interne

RS-X82 EV-2023

Version

10/07/2023

Version

1

Page

1 / 4

1. Identification / reconnaissance



2. Immobilisation / stabilisation / levage

Immobilisation



Arrêt moteur



3. Neutraliser les dangers directs / règles de sécurité

Batterie 12 Volts

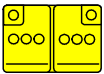

1- Arrêt moteur

2 - Déconnecter la borne négative (-)

Batterie 400 Volts



Uniquement en cas de désincarcération :
Déconnection de la batterie 400 Volts par retrait du Service-plug

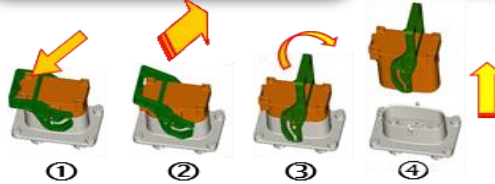
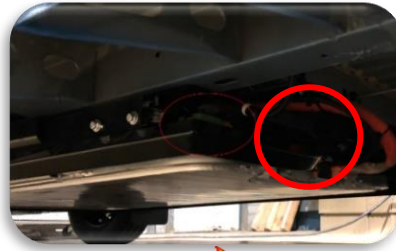
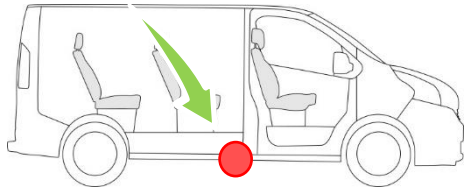

4. Accès aux occupants

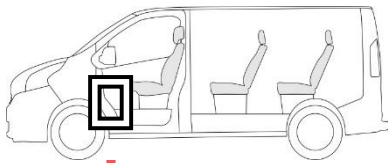

Présence de renforts bilatéraux
sous la console centrale

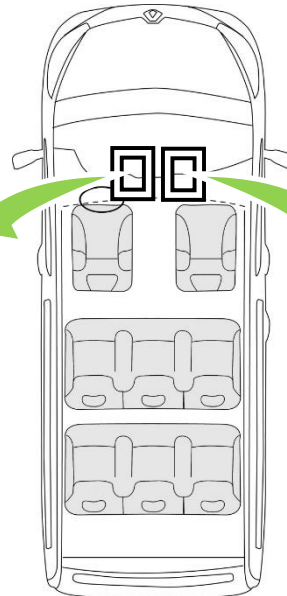

ACIERS RENFORCES

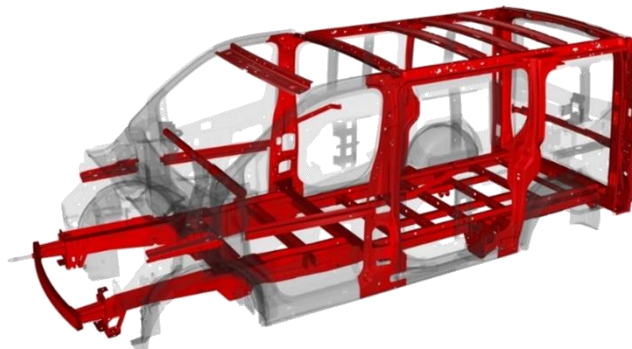
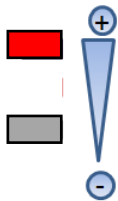

5. Énergie stockée / liquides / gaz / solides

	Lithium-ion	52 kW.h	400 V	
--	-------------	---------	-------	--

En concertation avec



MINISTÈRE DE L'INTÉRIEUR

Référence interne

Version

Version

Page

RS-X82 EV-2023

10/07/2023

1

3 / 4

6. En cas d'incendie

Extinction d'un feu de la batterie de traction

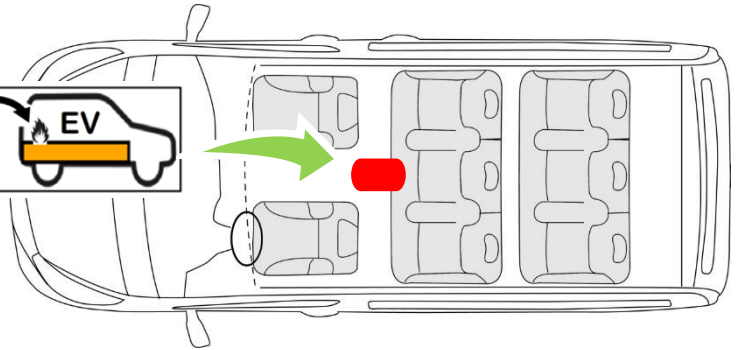

Si batterie de traction en feu : → Extinction à l'eau par remplissage

VERINS A GAZ



Risque d'effet missile des vérins à gaz

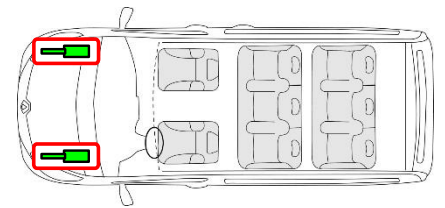

7. En cas d'immersion



Pas de risque électrique

8. Remorquage / transport / stockage



10. Explication des pictogrammes utilisés

	Véhicule électrique hybride fonctionnant avec un carburant liquide du groupe 2				
	Eloigner la clé main-libre		Capot		Utiliser une caméra thermique infrarouge
	Inflammable		Dangereux pour la santé humaine		Danger pour l'environnement
Gants de protection 	Ecran facial 	Appareil respiratoire 	Utiliser de l'eau pour éteindre l'incendie 	Ne pas casser, ni ouvrir 	