



RENAULT

# TRAFIC VAN E-TECH Electric



All types  
(2023 - )

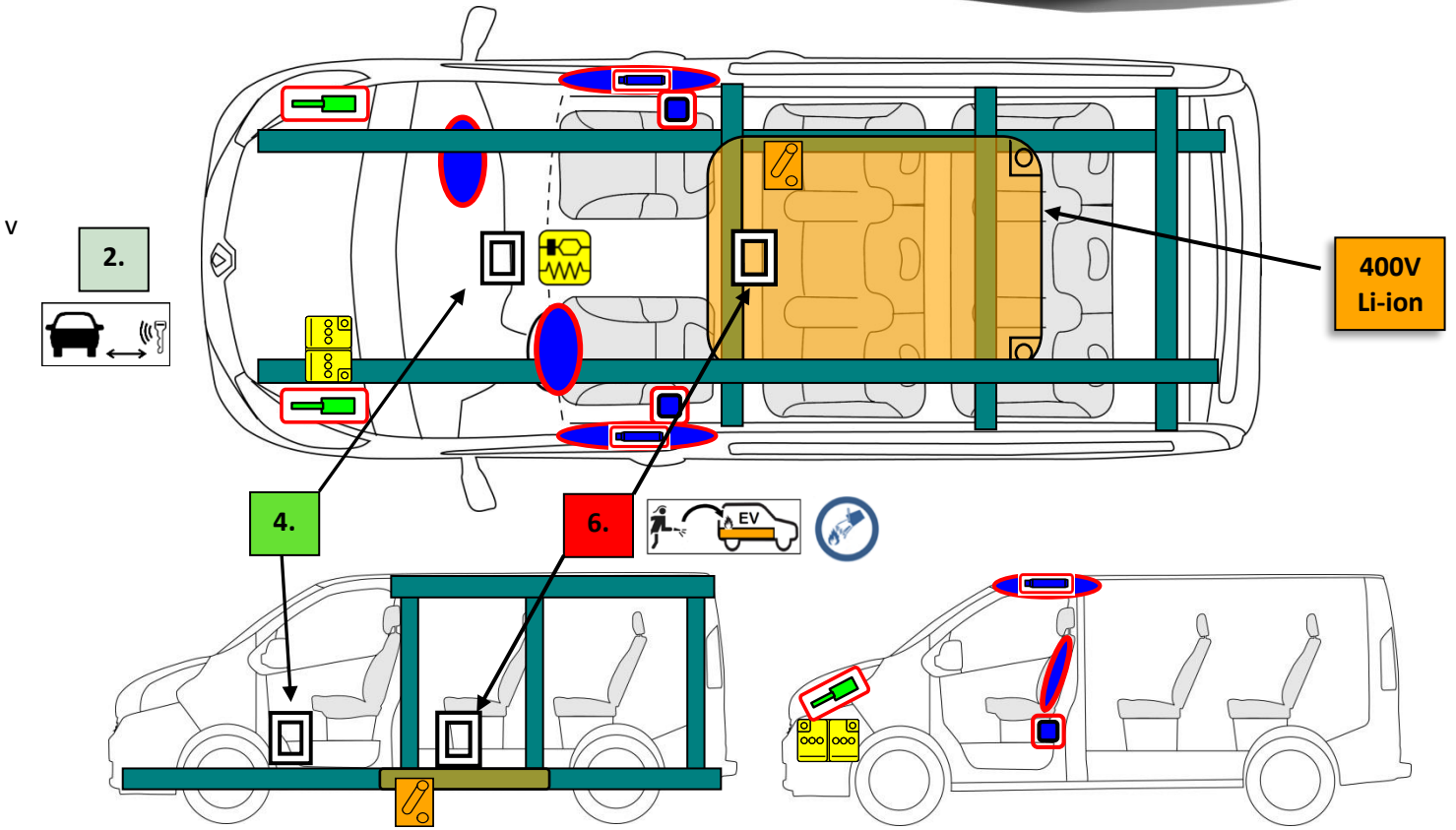

	Airbag		Stored gas inflator		Seat belt pretensioner		SRS control unit		
			Gas strut / Preloaded spring		High strength zone		Zone requiring special attention		
	Battery low voltage								
	Battery pack, high-voltage		High voltage power cable		High voltage device that disconnects high voltage				

In consultation with



MINISTÈRE DE L'INTÉRIEUR

Internal reference

RS-X82 EV-2023

Version

10/07/2023

Version

1

Page

1 / 4

## 1. Identification / recognition



## 2. Immobilisation / stabilisation / lifting

### Immobilisation



### Engine shutdown

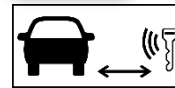

## 3. Disable direct hazards / safety regulations

### 12 Volts Battery

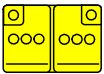

1- Engine shutdown

2 - Disconnect the negative terminal (-)

## 400 Volts battery



**Only if cutting operation is necessary :**

Disconnection of the 400 Volts battery by removing the service plug.

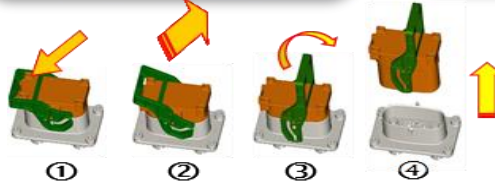
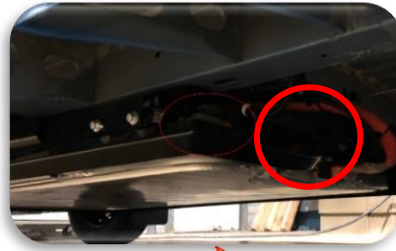
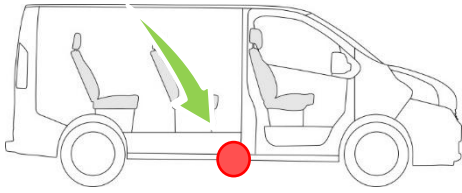

## 4. Access to the occupants

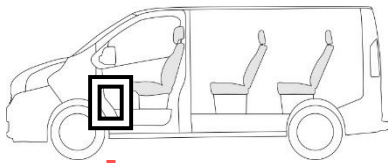

Bilateral reinforcements under the central consol

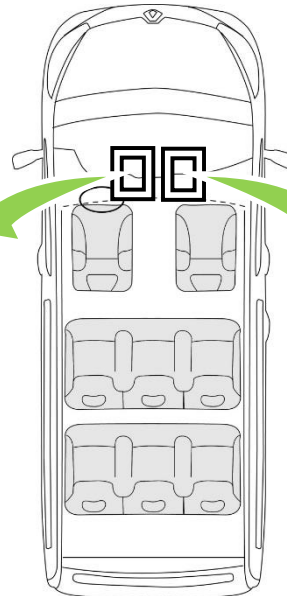

## HARDENED STEEL

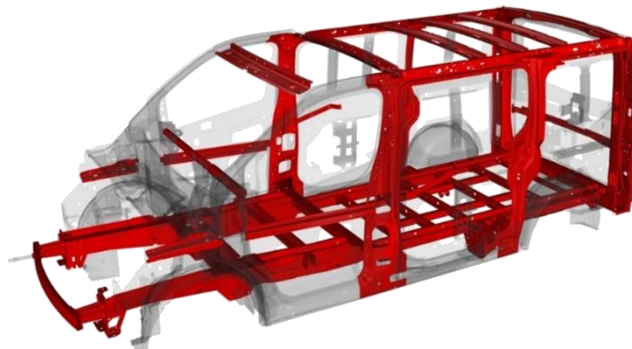
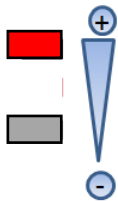

## 5. Stored energy / liquids / gases / solids

	Lithium-ion	52 kW.h	400 V	
--	-------------	---------	-------	--

In consultation with



MINISTÈRE DE L'INTÉRIEUR

Internal reference

Version

Version

Page

RS-X82 EV-2023

10/07/2023

1

3 / 4

## 6. In case of fire

### Extinguishing a traction battery fire propagation

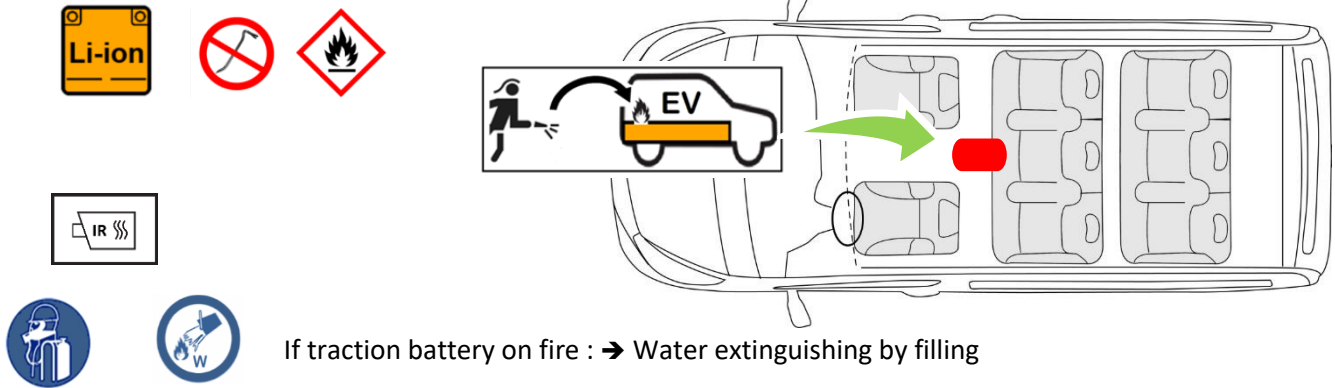

### GAS STRUTS

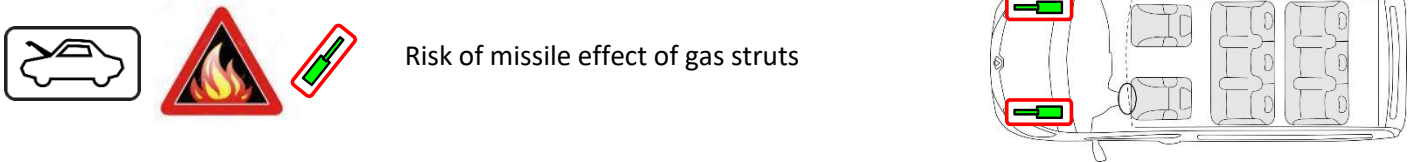







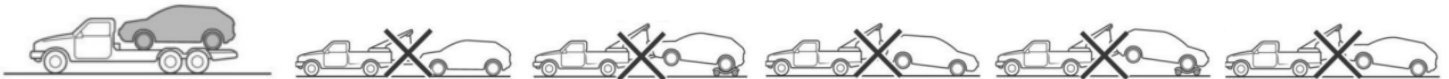



## 7. In case of submersion



## 8. Towing / transportation / storage



## 10. Explanation of pictograms used

 Hybrid Electric Vehicle on fuel of liquid group 2				
 Remove smart key		 Bonnet		 Use thermal Infrared camera
 Flammable		 Hazardous to the human health		 Environmental hazard
Electrical protection gloves 	Face shield 	Breathing apparatus (BA) 	Use water to extinguish the fire 	Don't break, nor open 